

# DF-G2 High Speed Expert™ Dual Display Small Object Counter

Instruction Manual

Original Instructions  
178236 Rev. E  
9 September 2015



178236

# Contents

1 Product Description	3
1.1 Models	3
1.2 Overview	4
1.3 Top Panel Interface	4
2 Installation Instructions	6
2.1 Mounting Instructions	6
2.2 Installing the Fibers	6
2.3 Fiber Adapters	7
2.4 Wiring Diagrams	7
3 Operating Instructions	8
3.1 Run Mode	8
3.2 Program Mode	8
3.2.1 TEACH Selection	8
3.2.2 Response Speed	9
3.2.3 Offset Percent	9
3.2.4 Totalizer Functions	9
3.2.5 Dynamic Event Stretcher	9
3.2.6 Display Readout	9
3.2.7 Factory Defaults	9
3.3 Remote Input	9
3.4 Adjust Mode	10
3.4.1 Window SET	10
3.4.2 Light SET	12
3.4.3 Dynamic TEACH	13
3.4.4 Troubleshooting	15
4 Specifications	17
4.1 Dimensions	18
4.2 Fiber Optic Array Dimensions	19
5 Accessories	21
5.1 Quick-Disconnect Cordsets	21
6 Banner Engineering Corp. Limited Warranty	23

# 1 Product Description

Advanced sensor with dual digital displays for small object counting applications

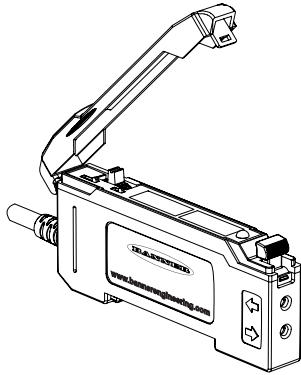

- Unique firmware designed to achieve accurate, high speed, low contrast performance for small object detection applications
- Percent-based threshold selectable from 2% to 50% for sensitivity adjustment
- Automatic Gain Compensation (AGC) algorithm compensates for dust build-up on fiber optics to extend counting cycle and maintain count accuracy
- Intelligent Dynamic Event Stretcher (DES) minimizing chance for double-counting, even with non-uniform objects (gel caps, washers, etc.)
- Alarm output provides notification upon extended block condition and marginal signal condition
- Totalizer feature allows user to configure output after certain count value is achieved
- Three TEACH methods include Window TEACH, Light Set TEACH, and Dynamic TEACH
- Fast response speeds of 25, 50, 150, 250, and 500 microseconds
- Easy to read dual digital displays show both signal level and threshold simultaneously
- Simple to use interface for easy setup and programming
- ECO (economy) display mode reduces amplifier power consumption by 25%



## WARNING: Not To Be Used for Personnel Protection

Never use this device as a sensing device for personnel protection. Doing so could lead to serious injury or death. This device does not include the self-checking redundant circuitry necessary to allow its use in personnel safety applications. A sensor failure or malfunction can cause either an energized or de-energized sensor output condition.

## 1.1 Models

Model	Outputs	Connector <sup>1</sup>
DF-G2-NC-2M	Single NPN, plus Health Mode output	2 m (6.5 ft) cable, 5-wire
DF-G2-PC-2M	Single PNP, plus Health Mode output	
DF-G2-NC-Q5	Single NPN, plus Health Mode output	150 mm (6 in) PVC cable with a 5-pin M12/Euro-style quick disconnect
DF-G2-PC-Q5	Single PNP, plus Health Mode output	
DF-G2-NC-Q7	Single NPN, plus Health Mode output	Integral 5-pin M8/Pico-style quick disconnect
DF-G2-PC-Q7	Single PNP, plus Health Mode output	

### <sup>1</sup> Connector options:

- A model with a QD connector requires a mating cordset (see [Quick-Disconnect Cordsets](#) on page 21)
- For 9 m cable, change the suffix 2M to 9M in the 2 m model number (example, DF-G2-NC-9M)
- For 150 mm (6 in) PVC cable with a 5-pin M8/Pico-style QD model, change the suffix 2M to Q3 in the 2 m model number (example, DF-G2-NC-Q3)
- For Q3 and Q7 models, use a 5-pin M8/Pico-style or a 6-pin M8/Pico-style mating cordset

Fiber Optic Arrays			
Models <sup>2</sup>	Detection Window Dimensions	Fiber Exit	Minimum Object Size <sup>3</sup>
PFCVA-10X25-S	10 mm x 25 mm	Side exit	1.5 mm
PFCVA-10X25-E		End exit	
PFCVA-25X25-S	25 mm x 25 mm	Side exit	3 mm
PFCVA-25X25-E		End exit	
PFCVA-34X25-S	34 mm x 25 mm	Side exit	4 mm
PFCVA-34X25-E		End exit	

## 1.2 Overview

The DF-G2 Expert Small Object Counter is a high performance plastic fiber optic amplifier that has been optimized for small object counting when using through-beam fiber optic arrays. The setup and configuration of the sensor has been simplified to the steps of applying power to the device with the fiber optic assemblies rigidly mounted in position. The user has access to a comprehensive collection of set-up and configuration parameters, but for most applications the default options will provide superb performance and reliability.

Several unique features of the DF-G2 Expert Small Object Counter sensor make it an ideal problem solver for many counting applications. The sensor includes: a “smart” OFF-delay (Dynamic Event Stretcher – DES) which varies its duration based on the detection event; a totalizing one-shot timer which triggers after a user selectable number of counting events; and an adaptive threshold which compensates for gradual environmental changes extending the useful operating period before a Health Mode output is triggered to indicate preventative maintenance is required.

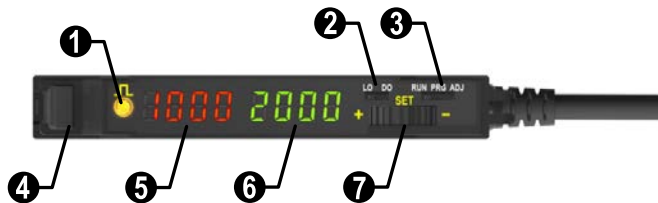

Figure 1. DF-G2 Model Features

1	Output LED
2	LO/DO Switch
3	RUN/PRG/ADJ Mode Switch
4	Lever Action Fiber Clamp
5	Red Signal Level
6	Green Threshold
7	+ /SET/- Rocker Button

## 1.3 Top Panel Interface

Opening the dust cover provides access to the top panel interface. The top panel interface consists of the RUN/PRG/ADJ mode switch, LO/DO switch, +/SET/- rocker button, dual red/green digital displays, and output LED.



### RUN/PRG/ADJ Mode Switch

The RUN/PRG/ADJ mode switch puts the sensor in RUN, PRG (Program), or ADJ (Adjust) mode. RUN mode allows the sensor to operate normally and prevents unintentional programming changes via the +/SET/- rocker button. PRG mode allows the sensor to be programmed through the display-driven programming menu (see [Program Mode](#) on page 8 ). ADJ mode allows the user to perform Expert TEACH/SET methods and Manual Adjust (see [Adjust Mode](#) on page 10 ).

<sup>2</sup> Custom fiber arrays and mounting configurations are possible. Consult factory for assistance with your small object counting application.

<sup>3</sup> With 2% threshold offset percentage



#### LO/DO Switch

The LO/DO switch selects Light Operate or Dark Operate mode. In Light Operate mode, the output is ON when the sensing condition is above the threshold. (For Window SET, the output is ON when the sensing condition is inside the window.) In Dark Operate mode, the output is ON when the sensing condition is below the threshold. (For Window SET, the output is ON when the sensing condition is outside the window.)

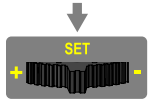

#### +/SET/- Rocker Button

The +/SET/- rocker button is a 3-way button. The +/- positions are engaged by rocking the button left/right. The SET position is engaged by clicking down the button while the rocker is in the middle position. All three button positions are used during PRG mode to navigate the display-driven programming menu. During ADJ mode, SET is used to perform TEACH/SET methods. The rocker button is disabled during RUN mode, except when using Window SET, see [Window SET](#) on page 10.



#### Red/Green Digital Displays

During RUN and ADJ modes, the Red display shows the signal level, and the Green display shows the threshold or the total counts. During PRG mode, both displays are used to navigate the display-driven programming menu.



#### Output LED

The output LED provides a visible indication when the output is activated.

## 2 Installation Instructions

### 2.1 Mounting Instructions

#### Mount on a DIN Rail

1. Hook the DIN rail clip on the bottom of the DF-G2 over the edge of the DIN rail (1).
2. Push the DF-G2 up on the DIN rail (1).
3. Pivot the DF-G2 onto the DIN rail, pressing until it snaps into place (2).

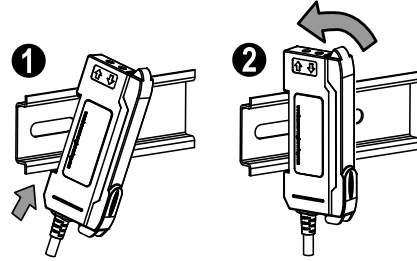

#### Mount to the Accessory Bracket

1. Position the DF-G2 in the SA-DIN-BRACKET.
2. Insert the supplied M3 screws.
3. Tighten the screws.

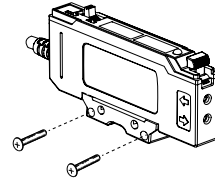

#### Remove from a DIN rail

1. Push the DF-G2 up on the DIN rail (1).
2. Pivot the DF-G2 away from the DIN rail and remove it (2).

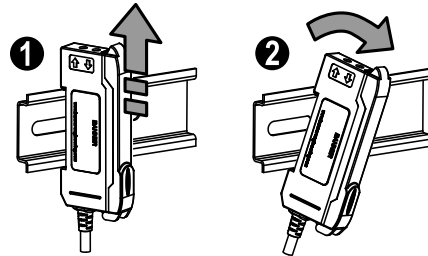

### 2.2 Installing the Fibers

Follow these steps to install glass or plastic fibers.

1. Open the dust cover.
2. Move the fiber clamp forward to unlock it.
3. Insert the fiber(s) into the fiber port(s) until they stop.
4. Move the fiber clamp backward to lock the fiber(s).
5. Close the dust cover.

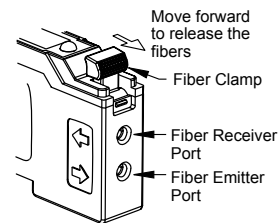

## 2.3 Fiber Adapters



**NOTE:** If a thin fiber with less than 2.2 mm outer diameter is used, install the fiber adapter provided with the fiber assembly to ensure a reliable fit in the fiber holder. Banner includes the adapters with all fiber assemblies.

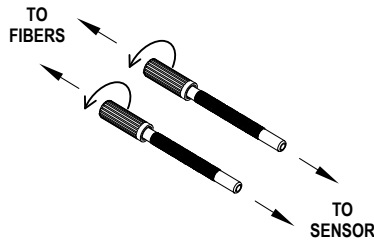

Fiber Outer Diameter (mm)	Adapter Color
Ø 1.0	Black
Ø 1.3	Red
Ø 2.2	No adapter needed

When connecting coaxial-type fiber assemblies to the amplifier, install the single-core fiber to the Transmitter port, and the multi-core fiber to the Receiver port. This will result in the most reliable detection.

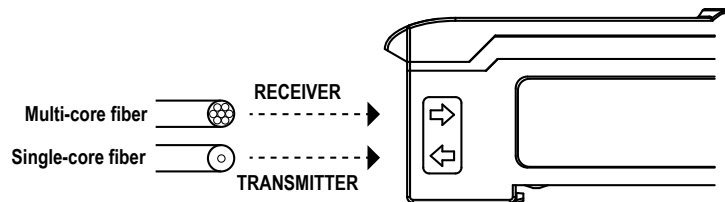

## 2.4 Wiring Diagrams

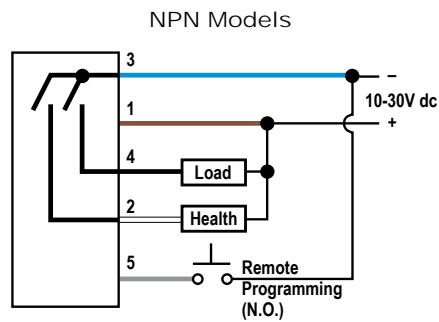
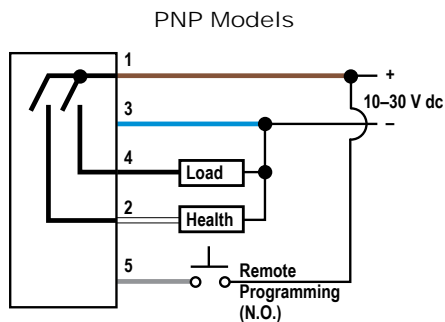

**Key**

- 1 = Brown
- 2 = White
- 3 = Blue
- 4 = Black
- 5 = Gray
- (6 = no connection)



**NOTE:** Open lead wires must be connected to a terminal block.

## 3 Operating Instructions



### 3.1 Run Mode

Run mode allows the sensor to operate normally and prevents unintentional programming changes. The +/SET/- rocker button is disabled during RUN mode, except when using Window SET, see [Window SET](#) on page 10.

In RUN Mode, the SET function of the +/SET/- rocker button allows the user to toggle between the threshold center value and the total number of counts on the Green display. If the Totalizer function is enabled, the total counts value increments to the programmed value and then starts over at 0. If the Totalizer function is disabled, the total counts value increments to 9999 and then starts over at 0. Changing any operational setting causes the total counts value to reset to 0.

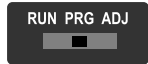

### 3.2 Program Mode

Program (PRG) mode allows the following settings to be programmed in the DF-G2 (refer to [Figure 2](#) on page 8 and [Figure 3](#) on page 10 for programming).

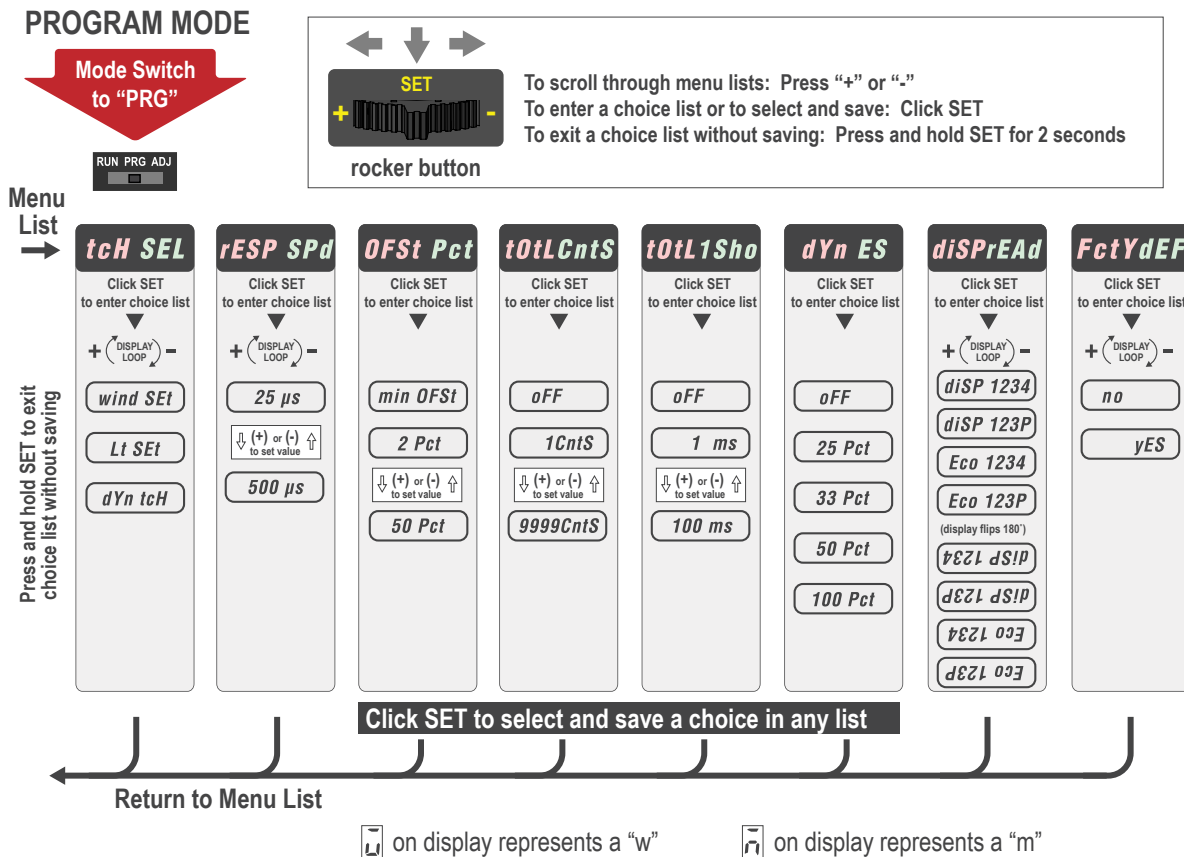

Figure 2.

#### 3.2.1 TEACH Selection **tCh SEL**

The DF-G2 can be programmed for one of the following TEACH/SET methods:

- Window SET
- Light SET
- Dynamic TEACH





NOTE: A TEACH Selection must be selected by programming before TEACH/SET methods can be used.

### 3.2.2 Response Speed

The DF-G2 can be programmed for one of the following Response Speeds:

Response Speed	Display Range	Crosstalk Avoidance Algorithm	Repeatability
25 $\mu$ s	0 – 4000	Disabled	12 $\mu$ s
50 $\mu$ s	0 – 4000	Disabled	12 $\mu$ s
150 $\mu$ s	0 – 4000	Disabled	30 $\mu$ s
250 $\mu$ s	0 – 4000	Enabled	50 $\mu$ s
500 $\mu$ s	0 – 9999	Enabled	80 $\mu$ s

### 3.2.3 Offset Percent

The Offset Percent is used during the Window, Light, or Dark SET methods. The threshold(s) are positioned a programmable % offset from the taught condition. The allowable range is 2% to 50%.

### 3.2.4 Totalizer Functions

The Totalizer function is a combination of the Total Counts setting and the Totalizer 1-Shot setting. To enable the Totalizer function, set the Total Counts to 1 or greater or set the Totalizer 1-Shot to 1 ms or greater. For example, if the Total Counts value is set to 100, the output signal will only turn on (or off in Light Operate) after 100 objects have been detected in the sensing area. The output pulse width default setting is 10 ms. With the Total 1-Shot setting this output pulse width can be changed from 1 ms to 100 ms.

If the Total Counts is set to off, the Total 1-Shot setting has no function. If the Total Counts is set to off and the Total 1-Shot setting is activated, the Total Counts is automatically set to 1 and can be changed from 1 to 9999 counts.

### 3.2.5 Dynamic Event Stretcher

The Dynamic Event Stretcher prevents errant double counts of translucent gel caps and other small objects of that type. When this function is enabled, the output is held on (or off in Light Operate) for a percentage of time longer than the detection event duration. For example, if the Dynamic event Stretcher is set to 50%, a 1 ms event would be stretched to 1.5 ms.

### 3.2.6 Display Readout

The readout of the digital displays can be programmed for the following options:

- Signal/Threshold readout - Numeric (1234) or % (123P)
- ECO mode - Enabled or Disabled (ECO mode dims the displays to reduce current consumption)
- Display Orientation - Normal (1234) or Flipped (tEzI)

### 3.2.7 Factory Defaults

The Factory Defaults menu allows the DF-G2 to be easily restored back to original factory default settings (see Factory Default Settings in [Specifications](#) on page 17).

## 3.3 Remote Input

The remote input may be used to perform TEACH/SET methods and to program the sensor remotely. Connect a switch between the gray wire of the sensor and ground (0Vdc). Pulse the remote input according to the diagram shown in [Figure 3](#) on page 10. Follow the instructions in the TEACH/SET sections in [Adjust Mode](#) on page 10 to perform a TEACH/SET method.

The sensor exits TEACH and remote programming modes after a 60 second timeout. Users may exit TEACH and remote programming modes by setting the remote input low for more than 2 seconds. In either case, the sensor returns to Run mode without saving any new settings.

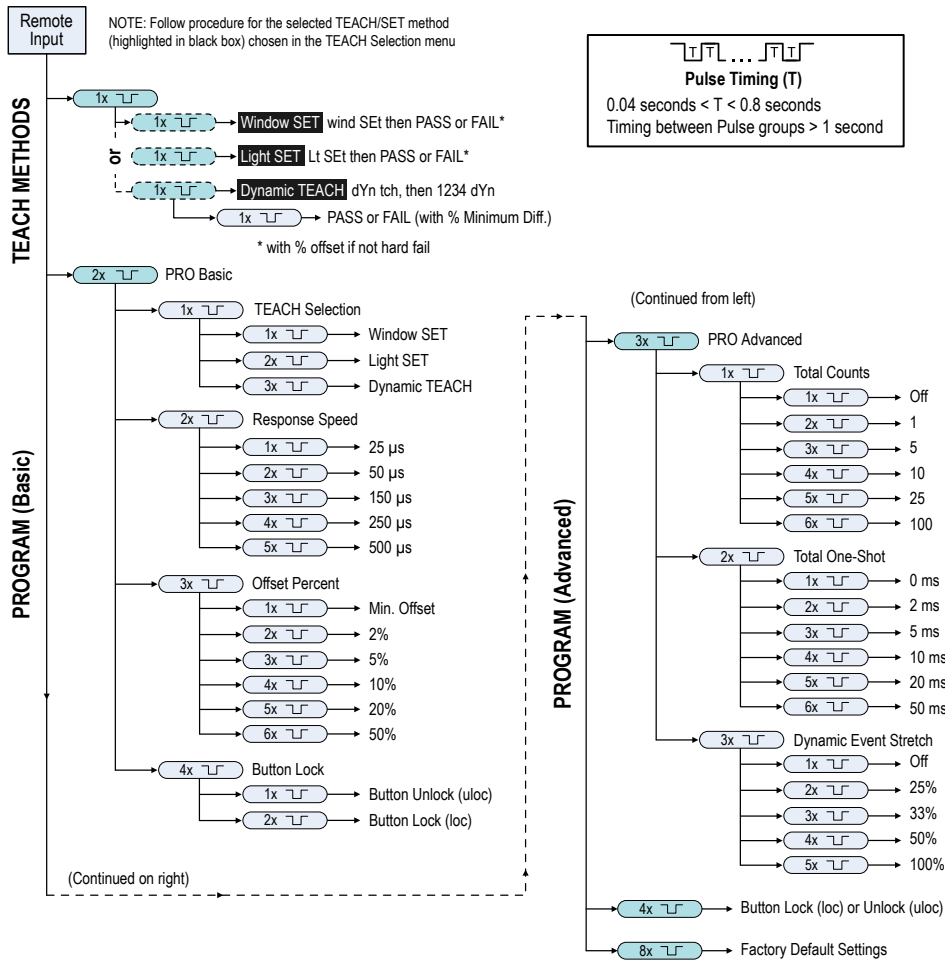
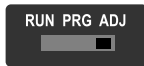

Figure 3. Remote Input Flowchart



### 3.4 Adjust Mode

Sliding the RUN/PRG/ADJ mode switch to the ADJ position allows the user to perform Expert TEACH/SET methods.

#### 3.4.1 Window SET

- Sets window thresholds that extend a programmable % offset above and below the presented condition
- All other conditions (lighter or darker) cause the output to change state
- Recommended for applications where a product may not always appear in the same place, or when other signals may appear
- See [Program Mode](#) on page 8 for programming the Offset Percent setting (to increase/decrease the window size)

A single sensing condition is presented, and the sensor positions window thresholds a programmable % offset above and below the presented condition. In LO mode, Window SET designates a sensing window with the Output ON condition inside the window, and the Output OFF conditions outside the window.

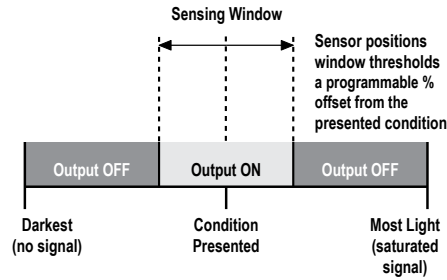

Figure 4. Window SET (Light Operate shown)



Output ON and OFF conditions can be reversed using the LO/DO switch.

Follow these steps to perform a Window SET:



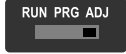

Note: TEACH Selection must be programmed to Window SET.

1. Enter Adjust Mode

Method	Action	Result
SET Button <sup>4</sup>	Set Mode switch to ADJ 	Display: Red - Signal Level; Green - Threshold
Remote Input <sup>5</sup>	No action required; sensor is ready for Window SET method	

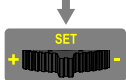
2. SET Sensing Condition

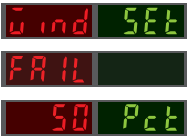

Method	Action	Result
SET Button	<ul style="list-style-type: none"> <li>Present sensing condition</li> <li>Click the SET rocker button</li> </ul> 	<p><u>Threshold Condition Accepted</u> Displays read "Wind SET" then alternate "PASS" with % Offset<sup>6</sup>; Sensor returns to Adjust mode</p>
Remote Input	<ul style="list-style-type: none"> <li>Present sensing condition</li> <li>Single-pulse the remote input</li> </ul> 	<p></p> <p><u>Threshold Condition Not Accepted</u> Displays read "Wind SET" then alternate "FAIL" with minimum % Offset<sup>6</sup> for sensing condition; Sensor returns to Adjust mode</p> <p></p>

3. Return to RUN Mode

<sup>4</sup> SET Button: 0.04 seconds ≤ "Click" ≤ 0.8 seconds

<sup>5</sup> Remote Input: 0.04 seconds ≤ T ≤ 0.8 seconds

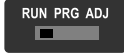
<sup>6</sup> See [Troubleshooting](#) on page 15 for more explanation of the % Offset displayed after the Window SET method

Method	Action	Result
SET Button	Move Mode switch to Run 	Display: Red - Signal Level; Green - Window Center (see <a href="#">Figure 5</a> on page 12 for instructions on how to display upper and lower thresholds)
Remote Input	No action required; sensor returns to Run mode automatically	

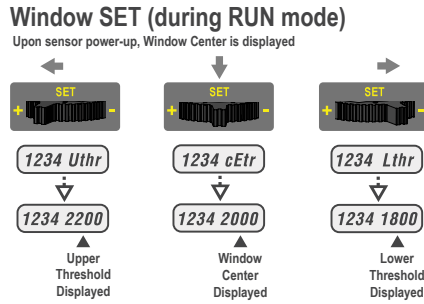

Figure 5. Upper and Lower Thresholds

### 3.4.2 Light SET

- Sets a threshold a programmable % offset below the presented condition
- Changes output state on any condition darker than the threshold condition
- Recommended for applications where only one condition is known, for example a stable light background with varying darker targets
- See [Program Mode](#) on page 8 for programming the Offset Percent setting

A single sensing condition is presented, and the sensor positions a threshold a programmable % offset below the presented condition. When a condition darker than the threshold is sensed, the output either turns ON or OFF, depending on the LO/DO setting.

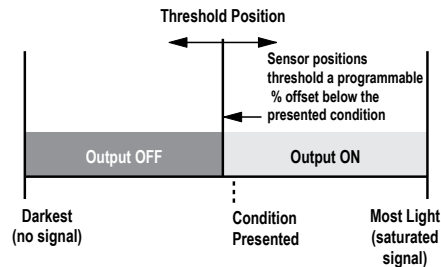

Figure 6. Light SET (Light Operate shown)



#### Light SET

Follow these steps to perform a Light SET:





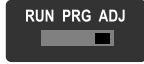



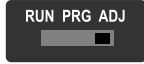

Note: TEACH Selection must be programmed to Lt SET.



1. Enter Adjust Mode

Method	Action	Result
SET Button <sup>7</sup>	Set Mode switch to ADJ 	Display: Red - Signal Level; Green - Threshold 
Remote Input <sup>8</sup>	No action is required; sensor is ready for Light SET method	

2. SET Sensing Condition

Method	Action	Result
SET Button	<ul style="list-style-type: none"> <li>Present sensing condition</li> <li>Click the SET rocker button</li> </ul> 	<p><u>Threshold Condition Accepted</u> Displays read "Lt SET" then alternate "PASS" with % Offset<sup>9</sup>; Sensor returns to Adjust mode</p>
Remote Input	<ul style="list-style-type: none"> <li>Present sensing condition</li> <li>Single-pulse the remote input</li> </ul> 	<p>  </p> <p><u>Threshold Condition Not Accepted</u> Displays read "Lt SET" then alternate "FAIL" with minimum % Offset<sup>9</sup> for sensing condition; Sensor returns to Adjust mode</p> <p>  </p>

3. Return to RUN Mode

Method	Action	Result
SET Button	Move Mode switch to RUN 	Display: Red - Signal Level; Green - Threshold 
Remote Input	No action required; sensor returns to RUN mode automatically	

3.4.3 Dynamic TEACH

- Teaches on-the-fly
- Establishes a single switching threshold

Dynamic TEACH is best used when a machine or process may not be stopped for teaching. The sensor learns during actual sensing conditions, taking multiple samples of the light and dark conditions and automatically setting the threshold at the optimum level.

<sup>7</sup> SET Button: 0.04 seconds ≤ "Click" ≤ 0.8 seconds

<sup>8</sup> Remote Input: 0.04 seconds ≤ T ≤ 0.8 seconds

<sup>9</sup> See [Troubleshooting](#) on page 15 for more explanation of the % Offset displayed after the Light SET method

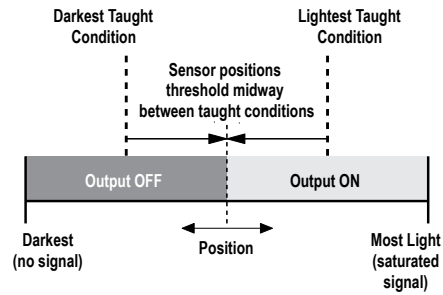

Figure 7. Dynamic TEACH (Light Operate shown)

The output ON and OFF conditions can be reversed using the LO/DO switch.



Dynamic TEACH

Follow these steps to perform Dynamic TEACH:





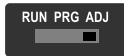

NOTE: TEACH Selection must be programmed to dYn tch.

1. Enter Adjust Mode.

Method	Action	Result
SET Button <sup>10</sup>	Set Mode switch to ADJ 	Display: Red - Signal Level; Green - Threshold
Remote Input <sup>11</sup>	No action required; sensor is ready for Dynamic TEACH method	

2. Enter Dynamic TEACH.

Method	Action	Result
SET Button	Click the SET rocker button 	Display: Flashes "dYn tch" then holds on "1234 dYn"
Remote Input	Single-pulse remote input 	 





3. Present ON and OFF Conditions.

Method	Action	Result
SET Button	Present ON and OFF conditions	Display: Red - Signal Level; Green - Threshold
Remote Input	Present ON and OFF conditions	



4. Exit Dynamic TEACH.

<sup>10</sup> SET Button: 0.04 seconds ≤ "Click" ≤ 0.8 seconds

<sup>11</sup> Remote Input: 0.04 seconds ≤ T ≤ 0.8 seconds

Method	Action	Result
SET Button	Click the SET rocker button 	<u>TEACH Accepted</u> Displays alternate "PASS" with % Minimum Difference <sup>12</sup> , Sensor returns to Adjust mode 
Remote Input	Single-pulse remote input 	<u>TEACH Not Accepted</u> Displays alternate "FAIL" with % Minimum Difference <sup>12</sup> , Sensor returns to Adjust mode 

5. Return to RUN Mode.

Method	Action	Result
SET Button	Move Mode switch to RUN 	Display: Red - Signal Level; Green - Threshold 
Remote Input	No action required; sensor returns to RUN mode automatically	

### 3.4.4 Troubleshooting

#### Percent Minimum Difference after TEACH

The Dynamic TEACH method will flash a % minimum difference on the displays after a PASS or FAIL.

Value	PASS/FAIL	Description
0 to 99%	FAIL	The difference of the taught conditions does not meet the required minimum
100 to 300%	PASS	The difference of the taught conditions just meets/exceeds the required minimum, minor sensing variables may affect sensing reliability
300 to 600%	PASS	The difference of the taught conditions sufficiently exceeds the required minimum, minor sensing variables will not affect sensing reliability
600% +	PASS	The difference of the taught conditions greatly exceeds the required minimum, very stable operation

#### Percent Offset after SET

The Window and Light SET methods will flash a % offset on the displays after a PASS or FAIL.



SET Result	% Offset Meaning
PASS (with % Offset)	Displays the % offset used for the SET method
FAIL (with % Offset)	Displays the minimum required % offset necessary to PASS the SET method

<sup>12</sup> See [Troubleshooting](#) on page 15 for more explanation of the % Minimum Difference displayed after the Dynamic TEACH method.

SET Result	% Offset Meaning
FAIL (without % Offset)	Presented condition cannot be used for the SET method

## Health Mode Alarm

The Health Mode Alarm alerts you when preventative maintenance becomes necessary to ensure reliable sensing. The Health Mode output 2 is Active when the system is OK and operating normally. Health Mode output 2 becomes Inactive when the system is in a marginal state because of contamination. The system still operates normally and can detect small objects, but is nearing the alarm state. When the system is completely contaminated and unable to ensure reliable sensing, the system goes into the alarm state. In the alarm state, the discrete output 1 is forced to the blocked state and can no longer be used to detect small objects.

- Threshold Alert  displays when Health Mode output 2 is inactive because of contamination. The system operates normally but is nearing the alarm state.
- Threshold Error  displays when discrete output 1 is forced to the blocked state and can no longer be used to detect small objects.

The sensor may enter Health Mode Alarm for any of these reasons:

1. When first powered up; the fiber optic array may already be contaminated
2. If the Window SET procedure fails, indicating the fiber optic array is contaminated and the sensor could not set a valid clear-state light level for reliable detection
3. If the fiber optic array is contaminated enough that the auto compensation tracking algorithm cannot sufficiently adjust the thresholds to ensure reliable detection
4. If the fiber optic array is blocked for more than 2 seconds

Return the system to normal operation by cleaning the fiber optic array and performing a Window SET to reset the clear-state light level (see [Window SET](#) on page 10).



## 4 Specifications

### Sensing Beam

Visible red, 635 nm

### Supply Voltage

10 to 30 V dc Class 2 (10% maximum ripple)

### Power and Current Consumption (exclusive of load)

Standard display mode: 960 mW, Current consumption < 40 mA at 24 V dc

ECO display mode: 720 mW, Current consumption < 30 mA at 24 V dc

### Supply Protection Circuitry

Protected against reverse polarity and transient overvoltages

### Delay at Power-Up

500 milliseconds maximum; outputs do not conduct during this time

### Output Configuration

1 current sinking (NPN) or 1 current sourcing (PNP) output, depending on model, plus 1 Health Mode output

### Output Rating

100 mA maximum combined load (derate 1 mA per °C above 30 °C)

OFF-state leakage current: < 5 µA at 30 V dc;

ON-state saturation voltage: NPN: < 1.5 V; PNP : < 2 V

### Output Protection

Protected against output short-circuit, continuous overload, transient overvoltages, and false pulse on power-up

### Output Response Time

25 µs

50 µs

150 µs

250 µs

500 µs

### Repeatability

12 µs

12 µs

30 µs

50 µs

80 µs

### Connections

PVC-jacketed 2 m or 9 m (6.5 ft or 30 ft) 5-wire integral cable; or integral 5-pin M8/Pico-style quick disconnect; or 150 mm (6 in) cable with a 5-pin M12/Euro-style quick disconnect; or 150 mm (6 in) cable with a 5-pin M8/Pico-style quick disconnect

For Q3 or Q7 5-pin models, either a 5-pin M8/Pico-style or a 6-pin M8/Pico-style mating cordset may be used

### Required Overcurrent Protection



**WARNING:** Electrical connections must be made by qualified personnel in accordance with local and national electrical codes and regulations.

Overcurrent protection is required to be provided by end product application per the supplied table.

Overcurrent protection may be provided with external fusing or via Current Limiting, Class 2 Power Supply.

Supply wiring leads < 24 AWG shall not be spliced.

For additional product support, go to <http://www.bannerengineering.com>.

Supply Wiring	Required Overcurrent Protection
20	5.0 Amps
22	3.0 Amps
24	2.0 Amps
26	1.0 Amps
28	0.8 Amps
30	0.5 Amps

### Adjustments

3-way RUN/PRG/ADJ Mode Switch

2-way LO/DO Switch

3-way +/SET/- Rocker Button

- Expert-style teaching (Dynamic TEACH, Light/Window SET)
- Response Speed, TEACH Selection, Offset Percent, Totalizer Functions, Dynamic Event Stretcher, Display Readout, Factory Defaults (from top panel or remote input)
- Top panel interface lockout (from remote input only)

### Factory Default Settings:

Setting	Factory Default
Threshold	3700 (typical)
TEACH Selection	Window SET
Response Speed	Standard: 250 µs
Offset Percent	2%
Totalizer Counts	OFF
Totalizer One-Shot	OFF
Dynamic Event Stretcher	50%
Display Readout	Numeric, ECO disabled, Normal Orientation

### Indicators

Red 4-digit Display: Signal Level

Green 4-digit Display: Threshold

(In Program Mode, Red and Green displays are used for programming menus)

Yellow LED: Output conducting

### Construction

Black ABS/polycarbonate alloy (UL94 V-0 rated) housing, clear polycarbonate cover

### Operating Conditions

Temperature: -10 °C to +55 °C (+14 °F to +131 °F)

Storage Temperature: -20 °C to +85 °C (-4 °F to +185 °F)

Humidity: 90% at +60 °C maximum relative humidity (non-condensing)

### Environmental Rating

IEC IEC IP50, NEMA 1

### Certifications



## 4.1 Dimensions

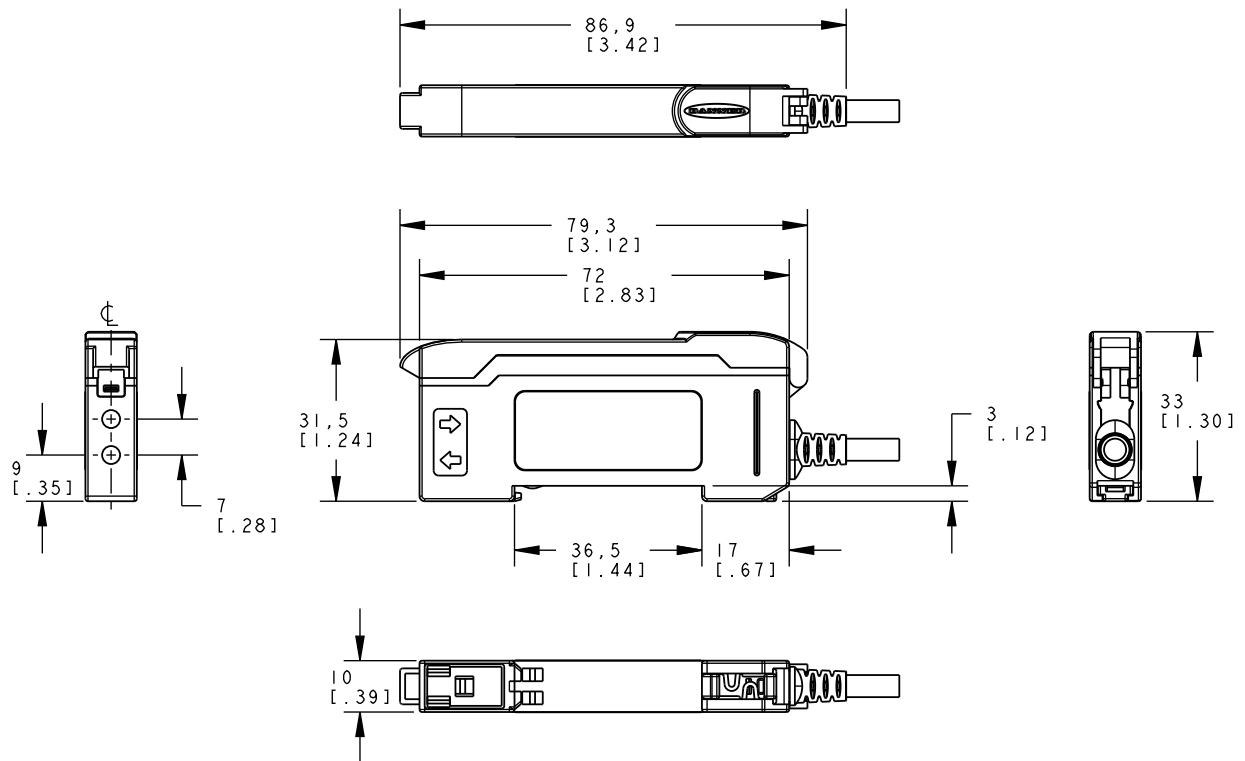

## 4.2 Fiber Optic Array Dimensions

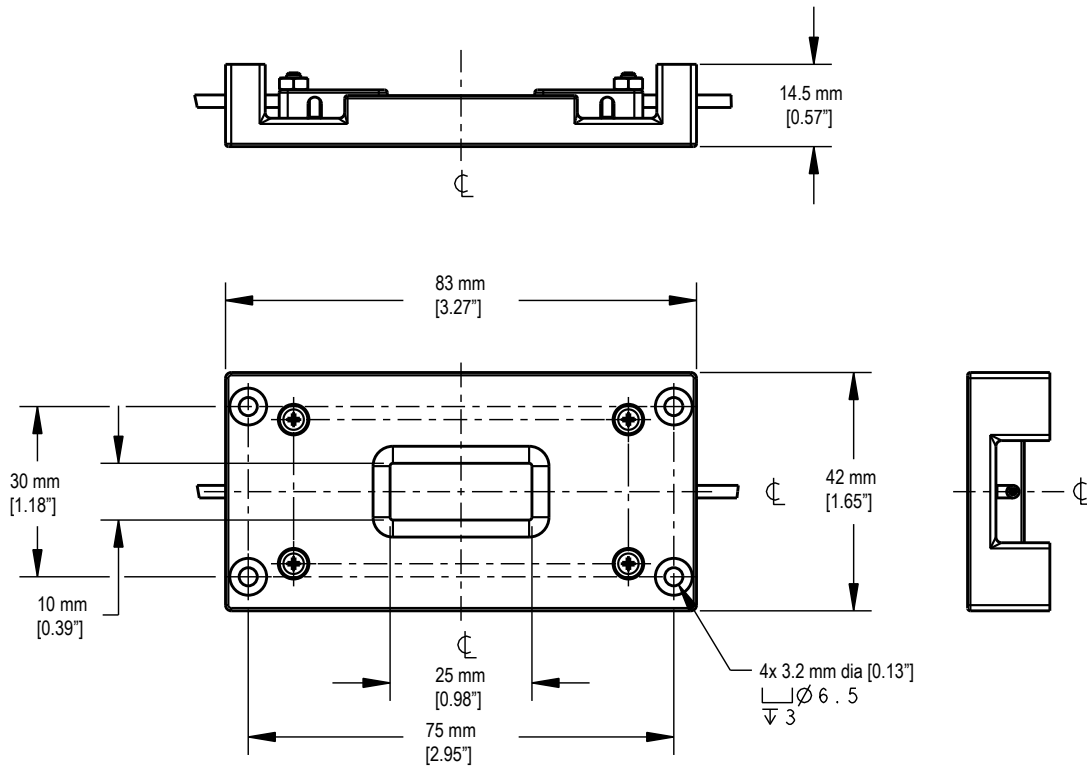

Figure 8. PFCVA-10X25-S and PFCVA-10X25-E

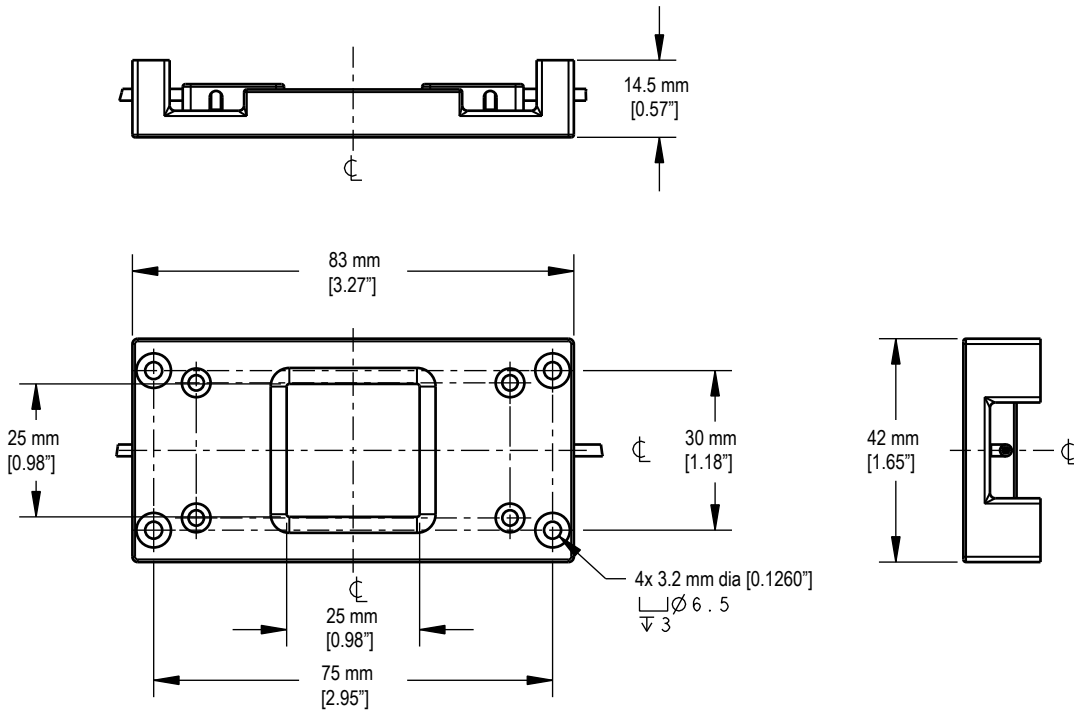

Figure 9. PFCVA-25X25-S and PFCVA-25X25-E

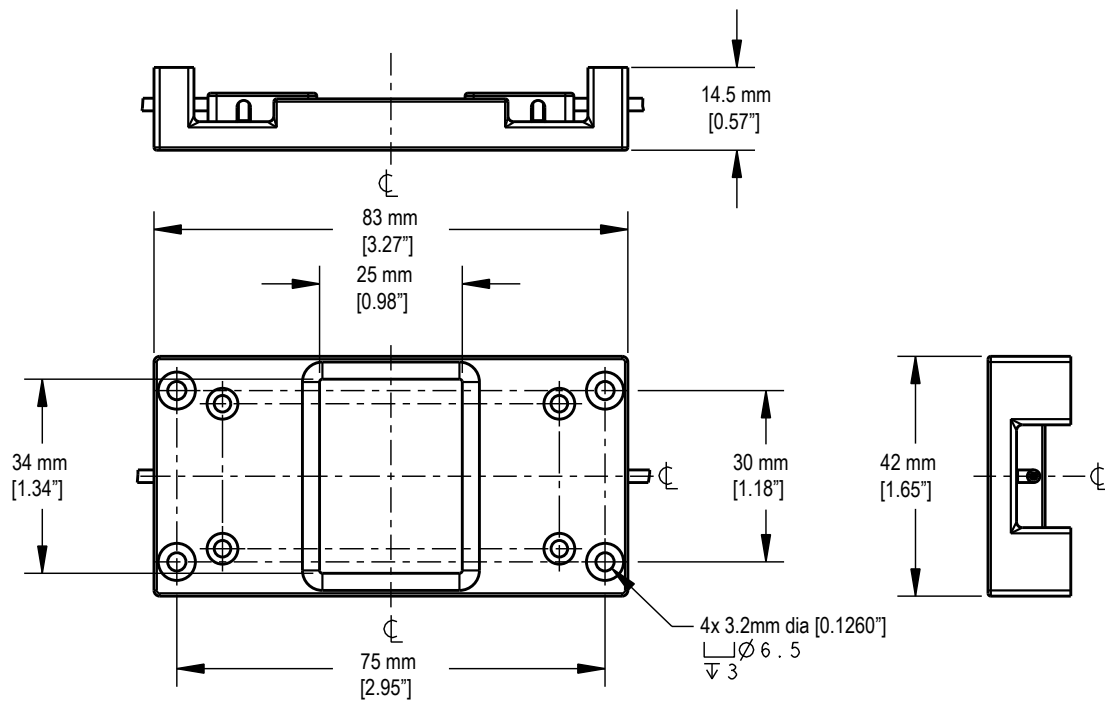

Figure 10. PFCVA-34X25-S and PFCVA-34X25-E

## 5 Accessories

### DIN-35-..

35 mm DIN Rail

Model	Length
DIN-35-70	70
DIN-35-105	105
DIN-35-140	140

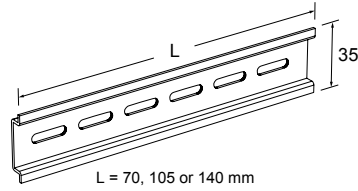

Hole center spacing: 35.1

Hole size: 25.4 x 5.3

### SA-DIN-CLAMP

- Pair of metal DIN rail end stops; slide onto DIN rail at either side of the sensor stack
- Combination (#2 Phillips, #8 standard slotted) set screw

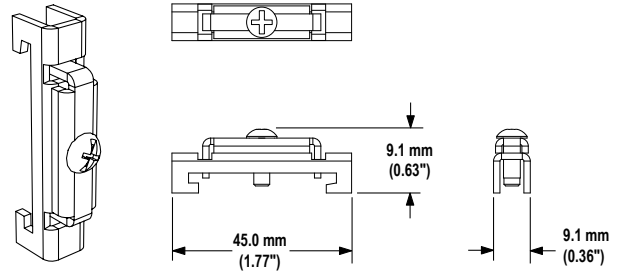

### SA-DIN-BRACKET

- Plastic bracket with mounting screws

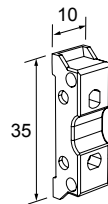

Hole center spacing: A = 16, B = 25.4, C = 15.2

Hole size: A =  $\varnothing$  3.2, B =  $\varnothing$  3.3, C =  $\varnothing$  4.4

### SA-DIN-BRACKET-10

- Package of 10 plastic brackets with mounting screws

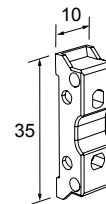

Hole center spacing: A = 16, B = 25.4, C = 15.2

Hole size: A =  $\varnothing$  3.2, B =  $\varnothing$  3.3, C =  $\varnothing$  4.4

## 5.1 Quick-Disconnect Cordsets

5-Pin Threaded M12/Euro-Style Cordsets—Single Ended				
Model	Length	Style	Dimensions	Pinout (Female)
MQDC1-501.5	0.50 m (1.5 ft)	Straight		<p>1 = Brown 2 = White 3 = Blue 4 = Black 5 = Gray</p>
MQDC1-506	1.83 m (6 ft)			
MQDC1-515	4.57 m (15 ft)			
MQDC1-530	9.14 m (30 ft)			
MQDC1-506RA	1.83 m (6 ft)	Right-Angle		
MQDC1-515RA	4.57 m (15 ft)			
MQDC1-530RA	9.14 m (30 ft)			

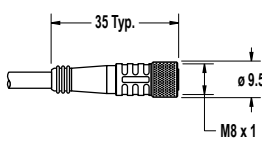
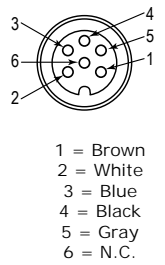
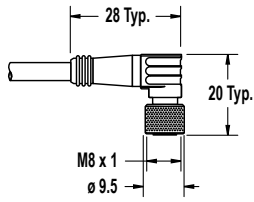
5-Pin Threaded M8/Pico-Style Cordsets				
Model	Length	Style	Dimensions	Pinout (Female)
PKG5M-2	2 m (6.56 ft)	Straight		 <p>1 = Brown 2 = White 3 = Blue 4 = Black 5 = Gray 6 = N.C.</p>
PKG5M-5	5 m (16.4 ft)			
PKG5M-9	9 m (29.5 ft)			
PKW5M-2	2 m (6.56 ft)	Right Angle		
PKW5M-5	5 m (16.4 ft)			
PKW5M-9	9 m (29.5 ft)			

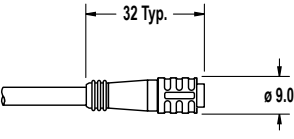
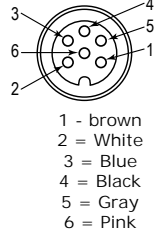
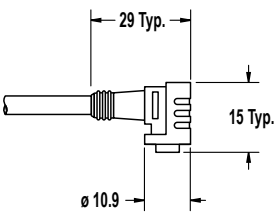
6-Pin Snap-on M8/Pico-Style Cordsets				
Model	Length	Style	Dimensions	Pinout (Female)
PKG6Z-2	2 m (6.5 ft)	Straight		 <p>1 - brown 2 = White 3 = Blue 4 = Black 5 = Gray 6 = Pink</p>
PKG6Z-9	9 m (30 ft)			
PKW6Z-2	2 m (6.5 ft)	Right-angle		
PKW6Z-9	9 m (30 ft)			

## 6 Banner Engineering Corp. Limited Warranty

Banner Engineering Corp. warrants its products to be free from defects in material and workmanship for one year following the date of shipment. Banner Engineering Corp. will repair or replace, free of charge, any product of its manufacture which, at the time it is returned to the factory, is found to have been defective during the warranty period. This warranty does not cover damage or liability for misuse, abuse, or the improper application or installation of the Banner product.

THIS LIMITED WARRANTY IS EXCLUSIVE AND IN LIEU OF ALL OTHER WARRANTIES WHETHER EXPRESS OR IMPLIED (INCLUDING, WITHOUT LIMITATION, ANY WARRANTY OF MERCHANTABILITY OR FITNESS FOR A PARTICULAR PURPOSE), AND WHETHER ARISING UNDER COURSE OF PERFORMANCE, COURSE OF DEALING OR TRADE USAGE.

This Warranty is exclusive and limited to repair or, at the discretion of Banner Engineering Corp., replacement. IN NO EVENT SHALL BANNER ENGINEERING CORP. BE LIABLE TO BUYER OR ANY OTHER PERSON OR ENTITY FOR ANY EXTRA COSTS, EXPENSES, LOSSES, LOSS OF PROFITS, OR ANY INCIDENTAL, CONSEQUENTIAL OR SPECIAL DAMAGES RESULTING FROM ANY PRODUCT DEFECT OR FROM THE USE OR INABILITY TO USE THE PRODUCT, WHETHER ARISING IN CONTRACT OR WARRANTY, STATUTE, TORT, STRICT LIABILITY, NEGLIGENCE, OR OTHERWISE.

Banner Engineering Corp. reserves the right to change, modify or improve the design of the product without assuming any obligations or liabilities relating to any product previously manufactured by Banner Engineering Corp.